



INSTALLATION INSTRUCTIONS

Accessory
ALL-SEASON FLOOR MATS
P/N 08P13-T0A-110

Application
2016 CR-V

Publications No.
VERSION 1
Issue Date
SEP 2015

Put this information in the glove box with the vehicle owner's manual.

PARTS LIST

Driver's all-season floor mat

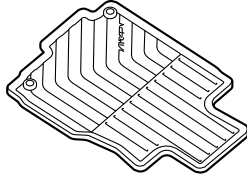

Passenger's all-season floor mat

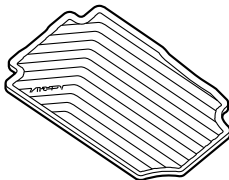

Rear all-season floor mat

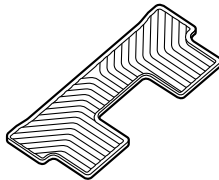
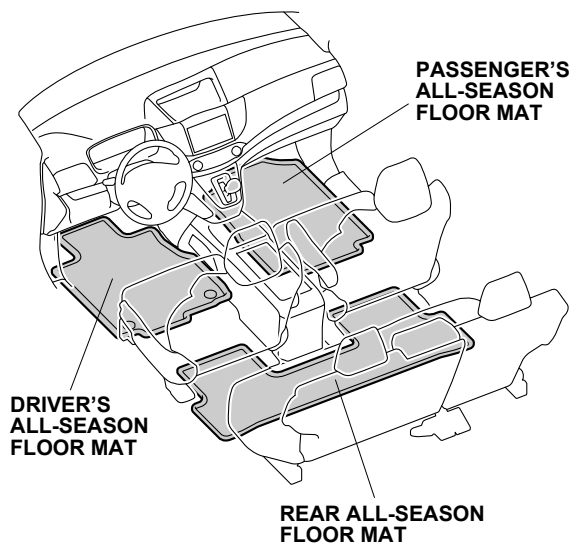

Illustration of the All-Season Floor Mats in the Vehicle



INSTALLATION

NOTE:

- Remove the standard floor mats before installing the all-season floor mats.
- An anchor is required for the driver's side of the vehicle; the anchor prevents the mat from sliding forward and possibly interfering with the pedals.
- If you remove the all-season floor mat, make sure you reanchor it when you put it back in your vehicle.
- If you replace the all-season floor mat, use factory all-season floor mat designed to be used with the anchor.
- If you use a non-factory mat in the driver's foot well, make sure it fits properly and that it can be used with the anchor.
- Do not put additional mats on top of the anchored mat, otherwise the additional mats may slide forward and possibly interfere with the pedals.
- Identify each mat by the marks on the back of each mat: the mat marked "R" or "Passenger's side" go on the right side of the vehicle; the mat marked "L" or "Driver's side" go on the left side.

1. Install the rings in the driver's all-season floor mat over the anchors. Turn the knob on each anchor 90° to secure the driver's all-season floor mat.

2 KNOBS Turn.

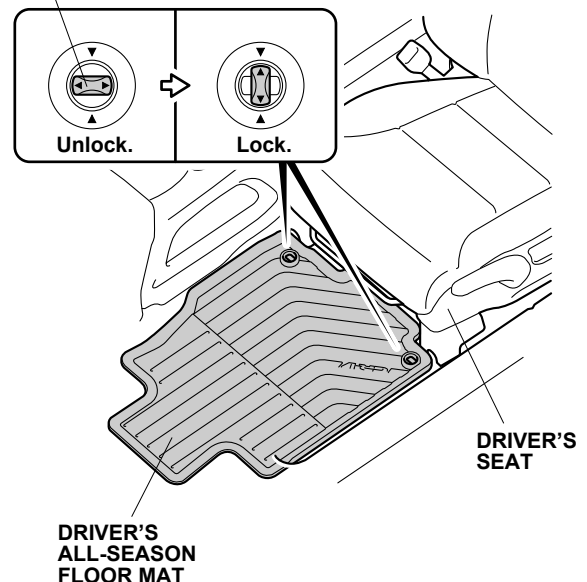

2. Position the passenger's all-season floor mat as shown. If equipped with a subwoofer, insert the rear portion of the passenger's all-season floor mat under a subwoofer.

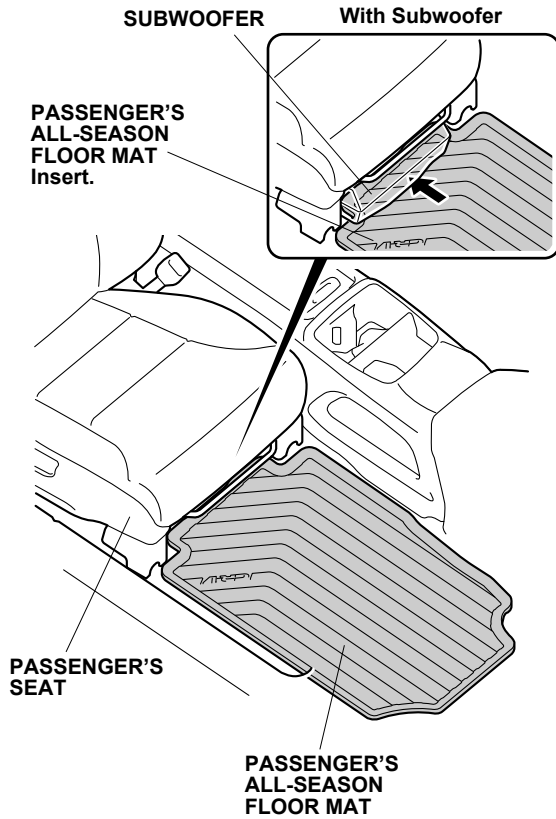

3. Position the rear all-season floor mat as shown.

